

# Multiple Phase Locked Loop Meditative Guidance using BioPhotonic Communication and BioAcoustic Fields – A Retroanalysis

Neela Iyer<sup>1</sup>, A.Prabhu Britto<sup>2</sup>, K. Sridhar<sup>3</sup>, Justin Chernow<sup>4</sup>, Elizabeth Maier<sup>5</sup>, Sant Maa Vaishnavi Devi<sup>6</sup>, Sant Maa Ananta Devi<sup>7</sup>, Sant Maa Aparna Devi<sup>8</sup>, Dhyanyogi Omdasji Maharaj<sup>9</sup>

1, 6-9 Shri Madhusudan Dhyanyoga Niketan Ashram, Ahmedabad, INDIA

[neela.iyer.16@gmail.com](mailto:neela.iyer.16@gmail.com)

2 Dean (R&D) and Professor of Electronics & Communication Engineering and BioMedical Engineering, VMKV Eng. College, VM University, Salem, INDIA

3 Sridhar's Sangeetha Swarangal, Chennai

4&5 Institute of Transpersonal Psychology, Palo Alto, CA, USA

## ABSTRACT:

This research work is a sustained attempt to scientifically interpret the Meditative Guidance of the Divine Omdasji Sound Meditation (SR0000398348 dated 2006-09-13, United States Copyright Office) renowned to bring peace and calm to the meditating human subject. It is the outcome of inspiration dawned on the authors to scientifically investigate such phenomena connected with the Divine Omdasji Sound Meditation. The Divine Omdasji Sound Meditation has been found to have many properties that Science can explain. Signal Processing techniques are used to perform Spectral Analysis of the Divine Omdasji Sound Meditation. The results indicate presence of significant patterns of low decibel power infrasound in the Divine Omdasji Sound Meditation. This paper proposes interpretations to this and meditative guidance characteristics inferred from the experimental results. This work concentrates on presenting a retro-analysis of the explanation to the mystic phenomena of meditative guidance to multiple subjects using biophotonic communication and bioacoustic fields operating on the principles of the multiple phase locked loop.

**Keywords:** Divine Omdasji Sound Meditation, Meditation, Meditative Guidance, Infrasound, Low power, Spectral Analysis, Consciousness Communications, BioAcoustic Fields, BioPhotonic Communication

## INTRODUCTION

Meditation is characterized by the attainment of a restful yet fully alert physical and mental state practiced by many as a self-regulatory approach to emotion management [1]. It is a mental activity associated with attaining a deeply restful yet fully alert state [2] and is labeled as "A wakeful Hypo metabolic Physiologic State" [3].

Physiological alterations in the human subjects led to the attention of many researchers and journals to concentrate on Meditation, and its effect on the human subject was assessed in various ways. The idea of a body-mind connection is not a new one. In fact, it is only in the recent past that the two ideas have been seen as separate [4]. A series of research articles have been published on Meditation [5-9].

The Divine Omdasji Sound Meditation (SR0000398348 dated 2006-09-13, United States Copyright Office) is used for Meditation by human subjects and is renowned to cause a lot of beneficial physiological effects to the meditating human subject.

The following discussion introduces Meditation and provides the bridge knowledge between Meditation and Science, further elaborating on the scientific investigations carried out in this research work and the interpretation of the results thus obtained.

## MEDITATION, CONSCIOUSNESS AND MUSIC

Meditation is an ancient spiritual practice that has recently been studied due to its potential health promoting effects, and its status as a special form of consciousness. The recent decades have witnessed a marked change in the perspective of viewing Meditation as a solely mystic process of spiritual quest to a complementary effective method in several health situations [10].

In a survey of EEG characteristics of persons practicing Meditation, theta bursts were preceded and followed by alpha rhythm. Subject reports elicited during theta bursts indicated pleasant states with intact situational orientation and no subjective experiences related to sleep. It is hypothesized that theta burst may be the manifestation of a state adjustment mechanism which comes into play during prolonged low-arousal states, and which may be related to EEG patterns of relaxation in certain behavioral conditions [11].

Consciousness is a subtle phenomenon, which has so far resisted all attempts to understand it, in spite of the present 'race for consciousness' [12]. It has been debated in many areas, including brain sciences [13]. Changes in EEG coherence patterns were used to test a field model that posits a common field of "pure consciousness" linking all individuals. The

experimental data support a field model of consciousness [14]. While a considerable number of studies have been carried out with EEG, only few studies have used PET and fMRI [9, 15].

### **Consciousness**

Exploration and reflection on the interfacing of religion and the neurosciences in the last twenty-five years provide a unique point of convergence on the relationship between science and religion. By the 1990s, meaning-making and integrating consciousness emerged as shaping the agenda between religion and cognitive neuroscience. The emerging methodology combines analogical continuities among levels of complexity and metaphorical leaps of inferential patterning [16].

Also, Global brain imaging techniques (PET and fMRI) indicate that a different brain network is involved in moving the focus of attention from that involved in the initial processing of an attended input [17, 18].

Recent neuroscientific works on the problem have surprisingly neglected attention as a guide to consciousness [19].

Without attention to an input there is no awareness of it. Yet several recent papers on consciousness [20-23] have surprisingly neglected attention as a guide to understanding consciousness. The following paragraphs concentrate on Music as an attention input.

### **Music**

Meditation is defined as an exercise [24], which usually involves training the individual to focus the attention or consciousness in a single object, sound, concept or experience. Apart from Meditation, relaxation could also be induced through chemical means (muscle relaxant drugs, such as Valium) or through biofeedback techniques in which the subject's EMG activity is monitored and revealed to the subject *via* light or tone signals. Such biofeedback techniques allow persons to develop voluntary control over internal systems (such as heart rate, blood pressure, EEG activity) previously thought to be beyond such control [25].

The human being is thought of as a musical instrument. By changing the patterns and rhythms of sound and breath, it is possible to link all the systems of the body that regulate excitement, relaxation, action, reaction and intelligence. In basic meditation, only a small area of the brain was engaged while the addition

of selected sounds in Medical Meditation produced more pronounced levels of activation [26]. This research work concentrates on the Divine Omdasji Sound Meditation which uses Music as attentive input and the scientific interpretations arising out of the analysis done on the Divine Omdasji Sound Meditation.

## **SCIENTIFIC INVESTIGATIONS ON THE SOURCE OF EXPERIENCE**

Modern psychology has the tools to explain the nature of the experience, and this leads one to believe that it can explain the source of the experience [27]. The Divine Omdasji Sound Meditation is renowned to be a source of Meditative Experience and hence it was chosen for scientific experimentation.

The Divine Omdasji Sound Meditation is a series of Sanskrit vowels, consonants and words sung by Dhyanyogi Omdasji. An electronic drone is used to provide a monophonic effect or accompaniment to the chant of the Divine Omdasji Sound Meditation. While chanting the Divine Omdasji Sound Meditation, a series of words and notes issues forth from Dhyanyogi Omdasji. His singing is renowned to have a physiological effect on the listeners, often attributed to his lifelong intense yogic practices.

The physiological effects are known to manifest as calmness of the mind, easy entry into meditative states (characterized by low frequency EEG waves) accompanied with or without meditative experiences, cure for insomnia, quitting smoking habits, healing & emotional stability. Another view that is attributed by people to the Divine Omdasji Sound Meditation is that the Divine Omdasji Sound Meditation yield peace to the client, and could also purify the thought processes leading to possibly reduced crime rate in society.

The Divine Omdasji Sound Meditation is also renowned to awaken the Kundalini Power which is the goal of many spiritual practices. The aim of this and further research is to investigate the source of the experience so that more scientific interpretation can be given. To avoid disturbances due to ambient noise or other sources of sound, a professional studio recording was preferred. Therefore, a professional studio recording of the Divine Omdasji Sound Meditation chant was obtained and used for further scientific investigations.

## **MATERIALS AND METHODS**

The configuration of the computer used for analysis was a Pentium IV 2.66 GHz with 512 MB RAM

running on Microsoft Windows XP Media Center Edition Version 2002 with Service Pack 2. The software used for analysis was MATLAB 7.0.0 (R14). After analysis of the computational resources available and assuming that analysis of audio range up to 4 KHz was sufficient for human voice analysis, the Nyquist criteria yielded 8 KHz sampling rate. Since the professional studio recording was a stereo recording, it was modified as a 8 KHz 16 bit stereo audio file for duration spells of ten minutes each.

The odd labeled files recorded the first ten minutes of each quarter of the hour, and the even labeled files recorded the last ten minutes of each quarter of the hour, yielding 8 unique ten-minute recordings at 8 KHz 16 bit stereo for the entire Divine Omdasji Sound Meditation Chant approximating an hour. In the stereo recordings, the first channel data was obtained using MATLAB software and used for further analysis.

In this research work, ten-minute recordings have been scientifically analyzed. Since the audio data was recorded at 8 KHz sampling rate, a 600 second recording yielded  $4.8 \times 10^6$  data points. Figure 1 displays the original audio recording of the first 600 seconds of the Divine Omdasji Sound Meditation chant as an amplitude-time graph. The amplitude for each second was obtained by taking the mean of the 8000 sample points for each second. The X- axis denotes

the time in seconds and Y-axis denotes the mean amplitude in Volts or better expressed as milliVolts. It is found that a majority of data points lie in the 14 mV to 16mV range. To perform a detailed study of the graph, Figure 1 was zoomed. Figure 2 shows a zoomed portion that contains majority of the graph points of Figure 1. Thus the Divine Omdasji Sound Meditation chant was obtained in a form that could be scientifically investigated. Then, attention was focused on the methodology to be chosen for investigating the Divine Omdasji Sound Meditation chant data. One of the major effect that is known to be caused by the Divine Omdasji Sound Meditation is the alteration of EEG waves towards low frequency rhythms. The reason may be attributed to changes of electrical activity of the brain produced by auditory stimuli [28].

Perhaps, the alteration of brain waves to low frequency rhythms and hence transition among the rhythms could be attributed to the phenomena of phase-locking. Phase-locking plays a dominant role in the neural encoding of the spectrum of speech sounds [29]. This suggests that all these phenomena experienced by the subject could have been transferred from the Divine Omdasji Sound Meditation. Hence, spectral analysis of the Divine Omdasji Sound Meditation was carried out.

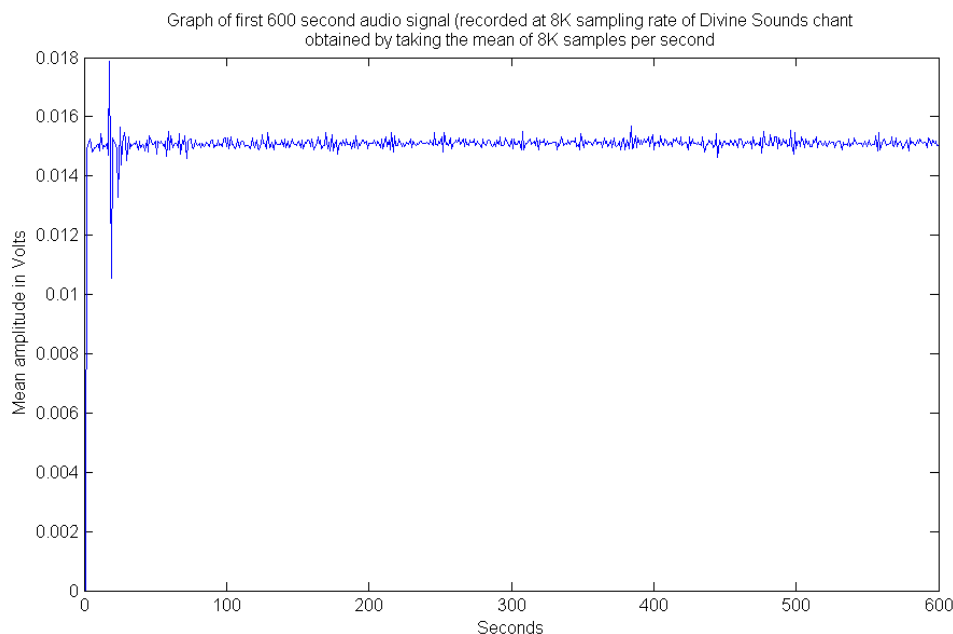

Fig.1 Graph of original audio recording of the first 600 seconds of Channel 1 of the Divine Omdasji Sound Meditation chant

Figure 1 shows the graph of the original audio recording of the first 600 seconds (ten minutes) of Channel 1 of the Divine Omdasji Sound Meditation chant. The audio recording had been performed on MATLAB software at 8 KHz 16 bit stereo, and the digital samples were obtained. This implies that 8000 data points (indicating amplitude) would represent every second of the Divine Omdasji Sound Meditation Chant. To construct the graph of the original audio signal, each 8000 data points was averaged for every second and the mean amplitudes were indicated against time, to obtain a time domain graph of the original audio recording.

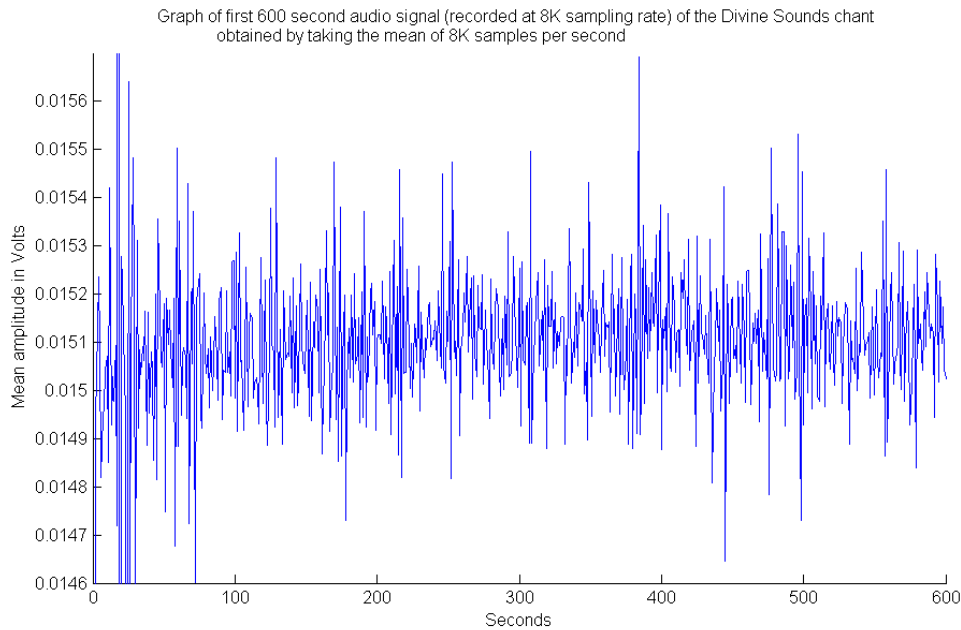

Fig.2 Zoomed Graph of original audio recording of the first 600 seconds of Channel 1 of the Divine Omdasji Sound Meditation chant  
Figure 2 shows a Zoomed Graph of Figure 1. This has been done by viewing the graph between Y axis limits of 14.6 mV to 15.6mV using MATLAB software. Figure 2 thus yields a better view of the original audio signal of the Divine Omdasji Sound Meditation chant corresponding to Channel 1 of the first 600 seconds.

**RESULTS**

The goal of spectral estimation is to describe the distribution (over frequency) of the power contained in a signal, based on a finite set of data. Estimation of power spectra is useful in a variety of applications, including the detection of signals buried in wide-band noise (MATLAB Signal Processing Toolbox Helpdesk available at [www.mathworks.com](http://www.mathworks.com)). Spectral Analysis of the Divine Omdasji Sound Meditation was carried out using MATLAB 7.0.0 (R14) software on a Pentium IV 2.66 GHz computer with 512 MB RAM running on Microsoft Windows XP Media Center Edition Version 2002 with Service Pack 2. Periodogram of the first ten minute recording of Divine Omdasji Sound Meditation was computed using Matlab and shown in Fig. 3. The periodogram plot showed frequencies in the range up to 4 KHz (maximum range set for this investigation). Of particular interest were the frequencies corresponding to the various EEG bands, especially the delta and theta EEG bands (for reasons discussed in the forthcoming paragraphs).

The EEG bands were chosen to be the following ranges.

- Delta: Greater than or equal to 0.1 Hz to less than 4 Hz
- Theta: Greater than or equal to 4 Hz to less than 8 Hz

- Alpha: Greater than or equal to 8 Hz to less than 14 Hz
- Beta: Greater than or equal to 14 Hz to less than 30 Hz

The recorded Divine Omdasji Sound Meditation audio was investigated for the presence of frequencies corresponding to the various frequency bands in the EEG rhythms. At the conventional range of -40 db from the maximum signal power, a few frequencies were observed in the alpha & beta ranges and the frequencies were plotted against power (in db) shown in Figures 4 & 5. All negative db level references henceforth will mean negative db level thresholds calculated from the maximum signal power. It is known that the actual signal power reduces drastically with decrease in db levels. Since the Divine Omdasji Sound Meditation audio signal is investigated for frequencies equivalent to very low frequency EEG rhythms less than 8 Hz (equivalent audio range falls in inaudible ranges), the authors investigated for frequencies corresponding to power levels which are very much less than the conventional -40 db range, hoping to find more information. The power of the audio signal was not a strict constraint when investigating inaudible frequency ranges. The low power of the inaudible signal is not a major factor of merit as the signal is already inaudible. Therefore, the inaudible frequency ranges (corresponding to equivalent very low frequency EEG rhythms) from the Periodogram of the first ten minute recording of the

Divine Omdasji Sound Meditation audio signal were investigated at very low power ranges of -60 db, -80 db and -100 db (from the maximum signal power). Spectral analysis of the Divine Omdasji Sound Meditation yielded Figures 4 to 73 showing stem plot of the frequencies that are observed in the respective threshold region (from maximum signal power) in the Divine Omdasji Sound Meditation recording of the

first ten minutes. The Graph is plotted with frequency on the X-axis and Power in db on the Y-axis. The cyan stem indicates the presence of the particular frequency ranges and the red crosses indicate the power (in db) present in that frequency in the Divine Omdasji Sound Meditation Recording of the first ten minutes.

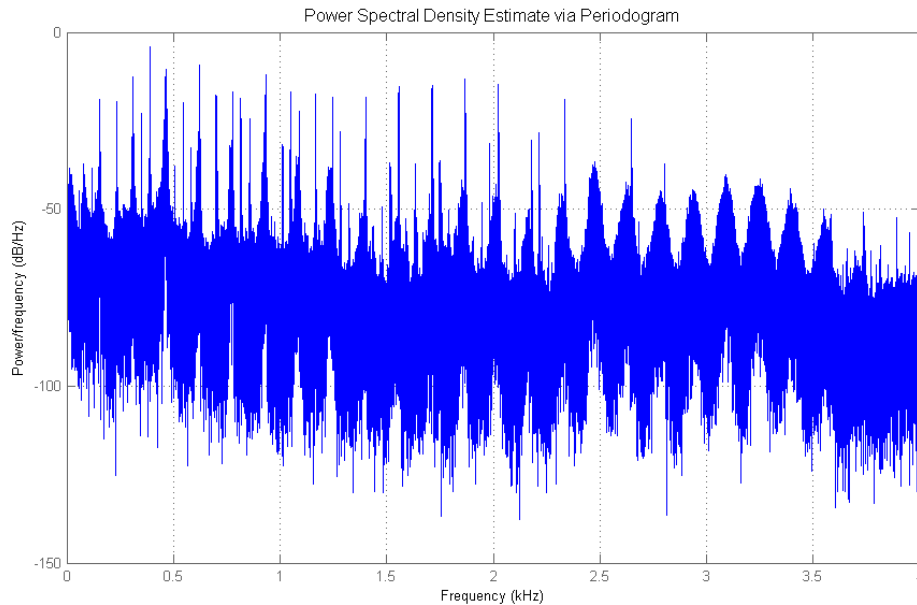

Fig. 3 Periodogram of first ten minute recording of Divine Omdasji Sound Meditation

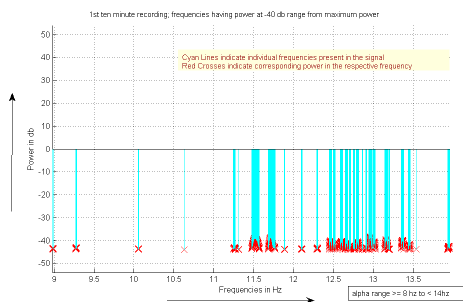

Fig. 4 Alpha Range frequencies present at -40 db threshold in the Divine Omdasji Sound Meditation recording of the first ten minutes

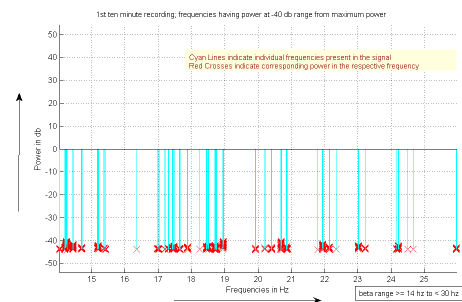

Fig. 5 Beta Range frequencies present at -40 db threshold in the Divine Omdasji Sound Meditation recording of the first ten minutes

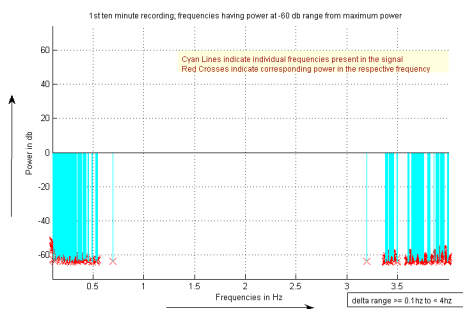

Fig. 6 Delta Range frequencies present at -60 db threshold in the Divine Omdasji Sound Meditation recording of the first ten minutes

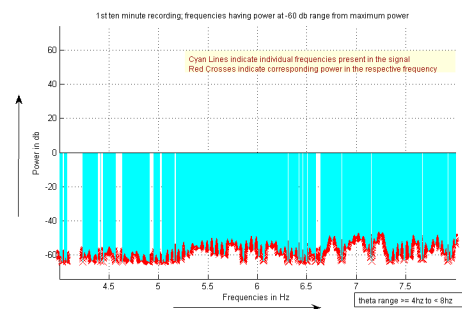

Fig. 7 Theta Range frequencies present at -60 db threshold in the Divine Omdasji Sound Meditation recording of the first ten minutes

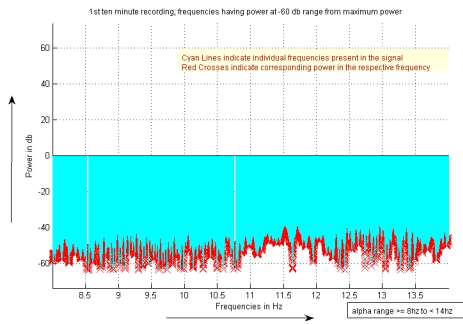

Fig. 8 Alpha Range frequencies present at -60 db threshold in the Divine Omdasji Sound Meditation recording of the first ten minutes

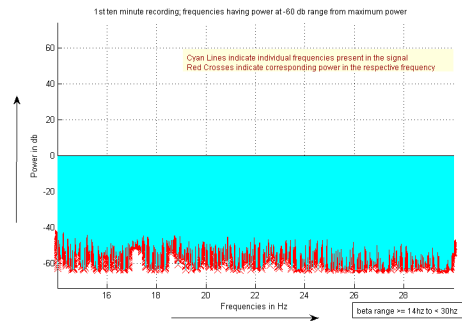

Fig. 9 Beta Range frequencies present at -60 db threshold in the Divine Omdasji Sound Meditation recording of the first ten minutes

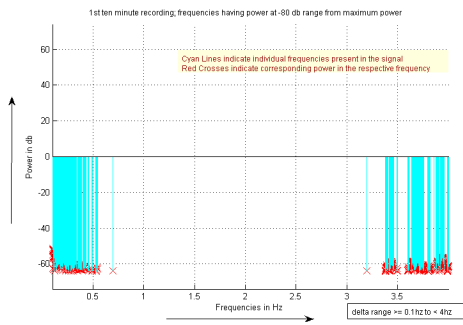

Fig. 10 Delta Range frequencies present at -80 db threshold in the Divine Omdasji Sound Meditation recording of the first ten minutes

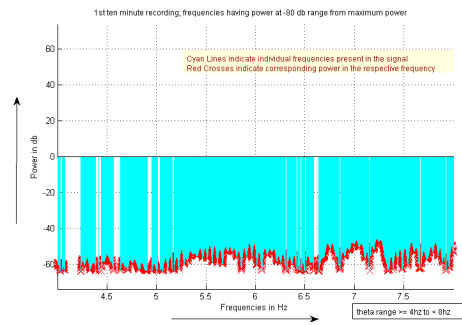

Fig. 11 Theta Range frequencies present at -80 db threshold in the Divine Omdasji Sound Meditation recording of the first ten minutes

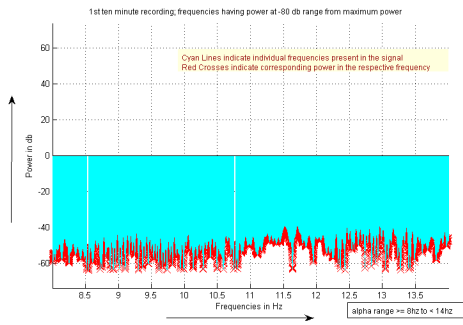

Fig. 12 Alpha Range frequencies present at -80 db threshold in the Divine Omdasji Sound Meditation recording of the first ten minutes

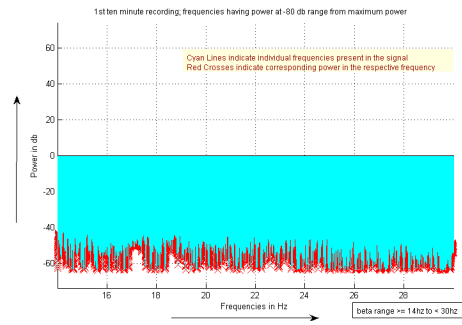

Fig. 13 Beta Range frequencies present at -80 db threshold in the Divine Omdasji Sound Meditation recording of the first ten minutes

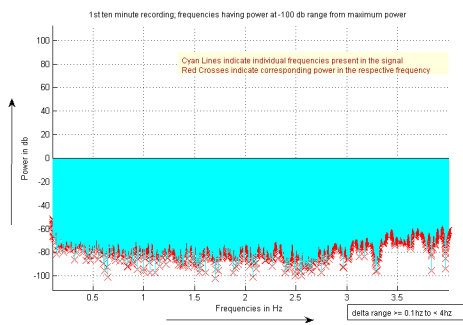

Fig. 14 Delta Range frequencies present at -100 db threshold in the Divine Omdasji Sound Meditation recording of the first ten minutes

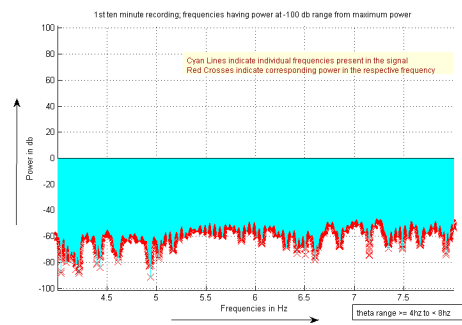

Fig. 15 Theta Range frequencies present at -100 db threshold in the Divine Omdasji Sound Meditation recording of the first ten minutes

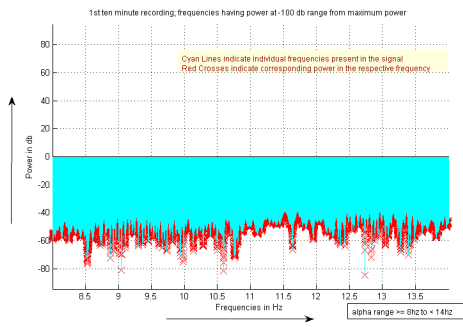

Fig. 16 Alpha Range frequencies present at -100 db threshold in the Divine Omdasji Sound Meditation recording of the first ten minutes

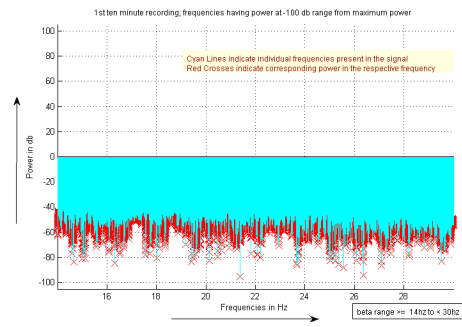

Fig. 17 Beta Range frequencies present at -100 db threshold in the Divine Omdasji Sound Meditation recording of the first ten minutes

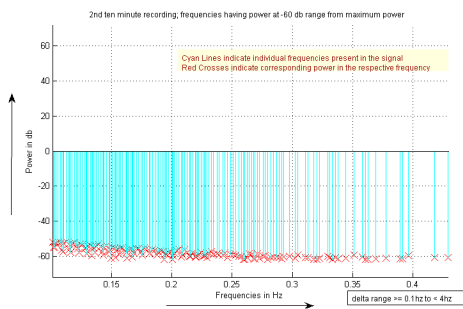

Fig. 18 Delta Range frequencies present at -60 db threshold in the Divine Omdasji Sound Meditation recording of the second ten minutes

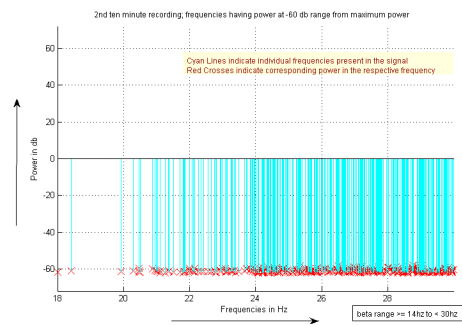

Fig. 19 Beta Range frequencies present at -60 db threshold in the Divine Omdasji Sound Meditation recording of the second ten minutes

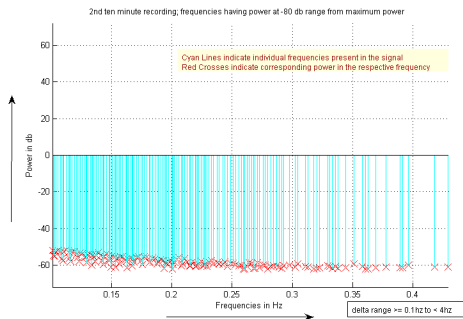

Fig. 20 Delta Range frequencies present at -80 db threshold in the Divine Omdasji Sound Meditation recording of the second ten minutes

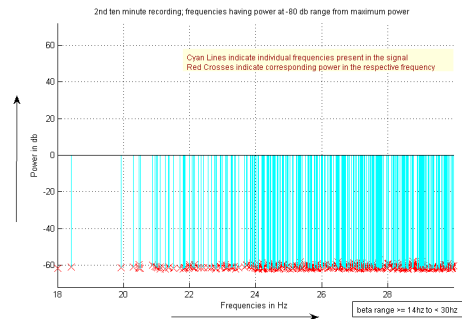

Fig. 21 Beta Range frequencies present at -80 db threshold in the Divine Omdasji Sound Meditation recording of the second ten minutes

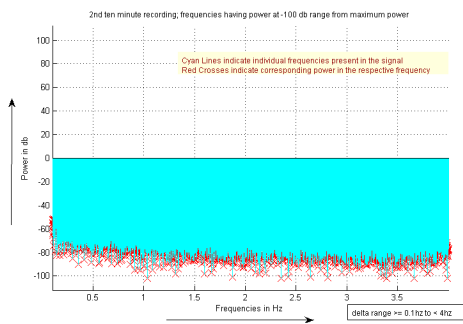

Fig. 22 Delta Range frequencies present at -100 db threshold in the Divine Omdasji Sound Meditation recording of the second ten minutes

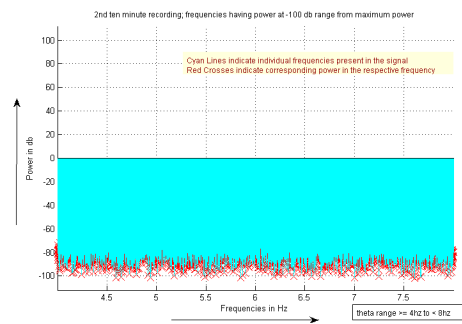

Fig. 23 Theta Range frequencies present at -100 db threshold in the Divine Omdasji Sound Meditation recording of the second ten minutes

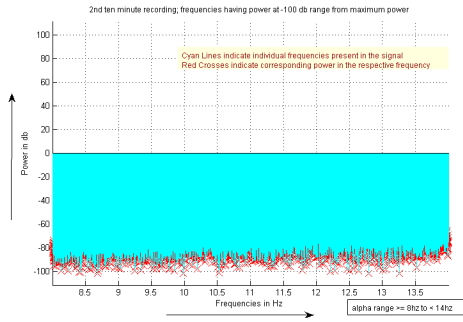

Fig. 24 Alpha Range frequencies present at -100 db threshold in the Divine Omdasji Sound Meditation recording of the second ten minutes

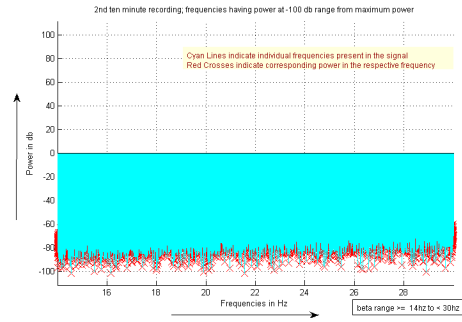

Fig. 25 Beta Range frequencies present at -100 db threshold in the Divine Omdasji Sound Meditation recording of the second ten minutes

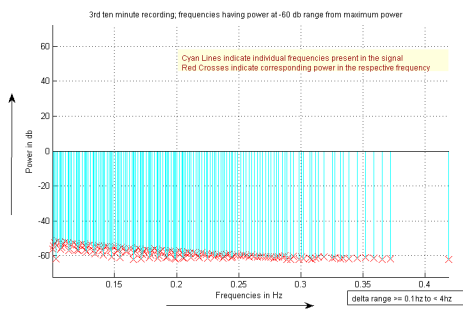

Fig. 26 Delta Range frequencies present at -60 db threshold in the Divine Omdasji Sound Meditation recording of the third ten minutes

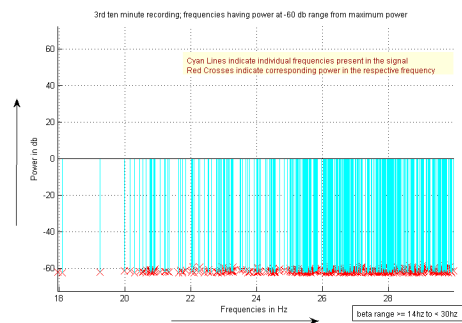

Fig. 27 Beta Range frequencies present at -60 db threshold in the Divine Omdasji Sound Meditation recording of the third ten minutes

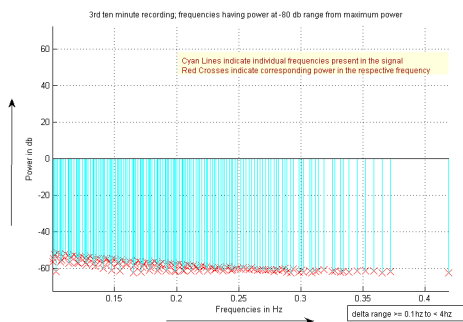

Fig. 28 Delta Range frequencies present at -80 db threshold in the Divine Omdasji Sound Meditation recording of the third ten minutes

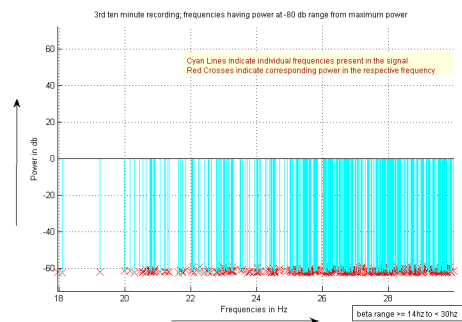

Fig. 29 Beta Range frequencies present at -80 db threshold in the Divine Omdasji Sound Meditation recording of the third ten minutes

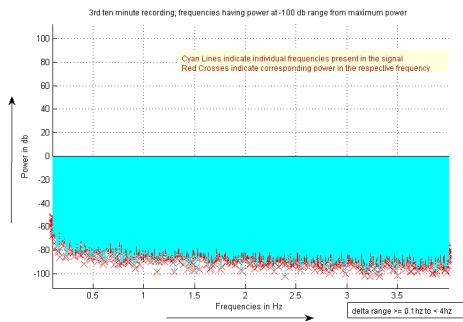

Fig. 30 Delta Range frequencies present at -100 db threshold in the Divine Omdasji Sound Meditation recording of the third ten minutes

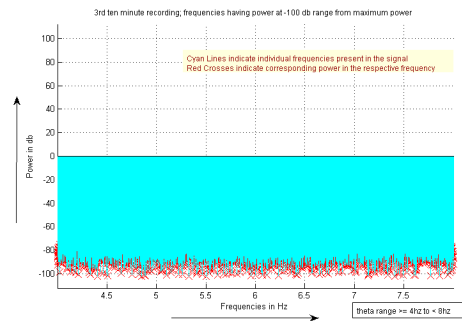

Fig. 31 Theta Range frequencies present at -100 db threshold in the Divine Omdasji Sound Meditation recording of the third ten minutes



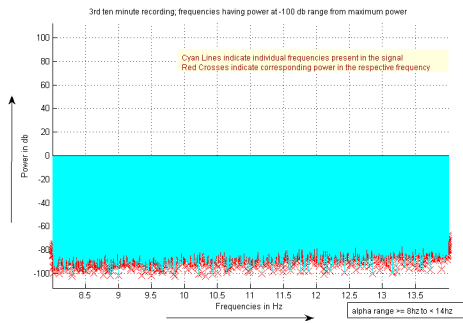

Fig. 32 Alpha Range frequencies present at -100 db threshold in the Divine Omdasji Sound Meditation recording of the third ten minutes

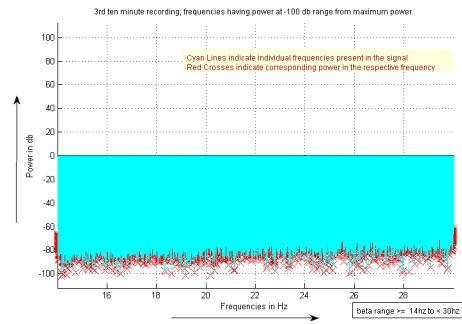

Fig. 33 Beta Range frequencies present at -100 db threshold in the Divine Omdasji Sound Meditation recording of the third ten minutes

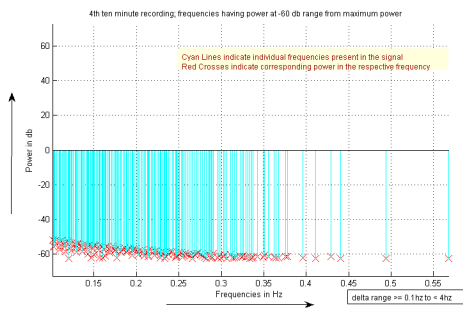

Fig. 34 Delta Range frequencies present at -60 db threshold in the Divine Omdasji Sound Meditation recording of the fourth ten minutes

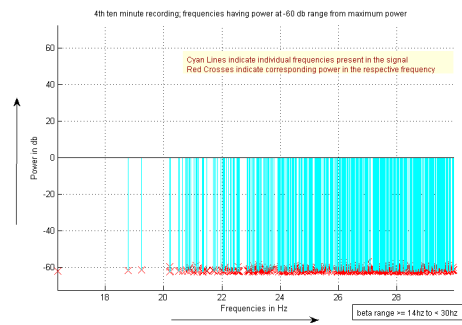

Fig. 35 Beta Range frequencies present at -60 db threshold in the Divine Omdasji Sound Meditation recording of the fourth ten minutes

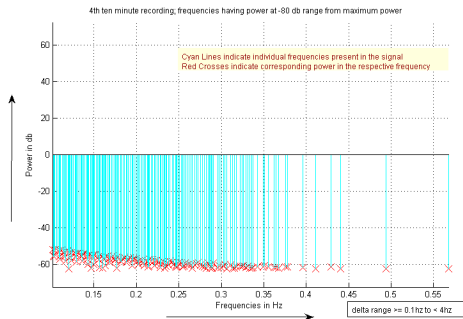

Fig. 36 Delta Range frequencies present at -80 db threshold in the Divine Omdasji Sound Meditation recording of the fourth ten minutes

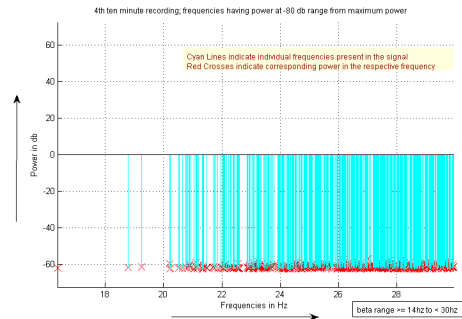

Fig. 37 Beta Range frequencies present at -80 db threshold in the Divine Omdasji Sound Meditation recording of the fourth ten minutes

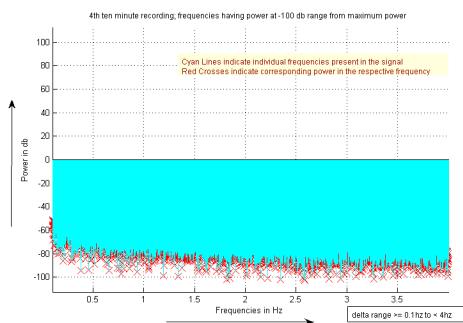

Fig. 38 Delta Range frequencies present at -100 db threshold in the Divine Omdasji Sound Meditation recording of the fourth ten minutes

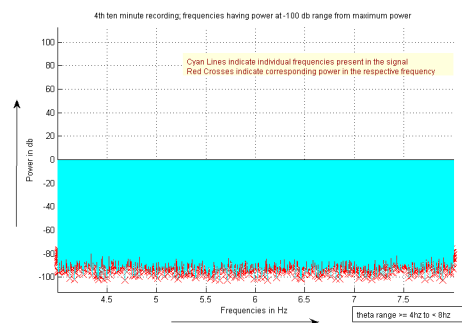

Fig. 39 Theta Range frequencies present at -100 db threshold in the Divine Omdasji Sound Meditation recording of the fourth ten minutes

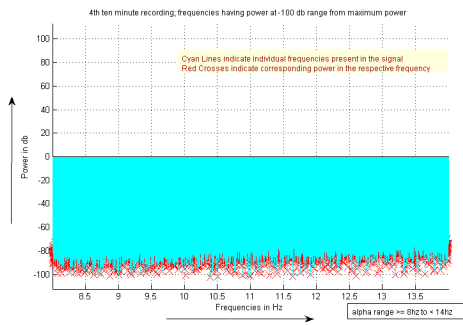

Fig. 40 Alpha Range frequencies present at -100 db threshold in the Divine Omdasji Sound Meditation recording of the fourth ten minutes

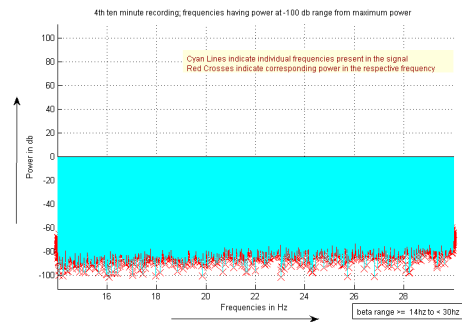

Fig. 41 Beta Range frequencies present at -100 db threshold in the Divine Omdasji Sound Meditation recording of the fourth ten minutes

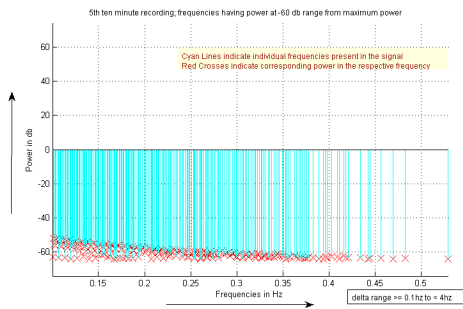

Fig. 42 Delta Range frequencies present at -60 db threshold in the Divine Omdasji Sound Meditation recording of the fifth ten minutes

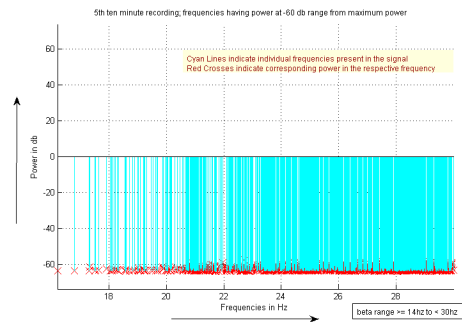

Fig. 43 Beta Range frequencies present at -60 db threshold in the Divine Omdasji Sound Meditation recording of the fifth ten minutes

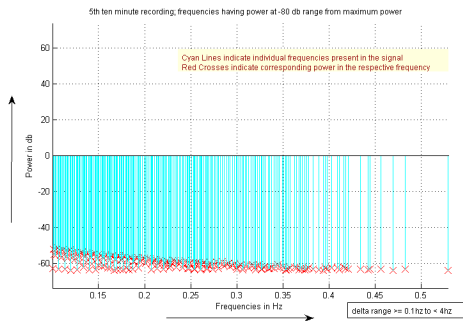

Fig. 44 Delta Range frequencies present at -80 db threshold in the Divine Omdasji Sound Meditation recording of the fifth ten minutes

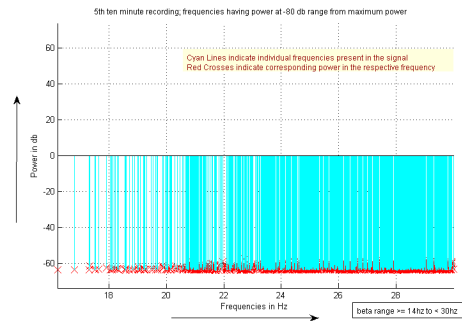

Fig. 45 Beta Range frequencies present at -80 db threshold in the Divine Omdasji Sound Meditation recording of the fifth ten minutes

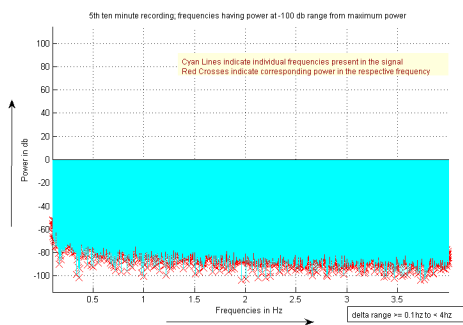

Fig. 46 Delta Range frequencies present at -100 db threshold in the Divine Omdasji Sound Meditation recording of the fifth ten minutes

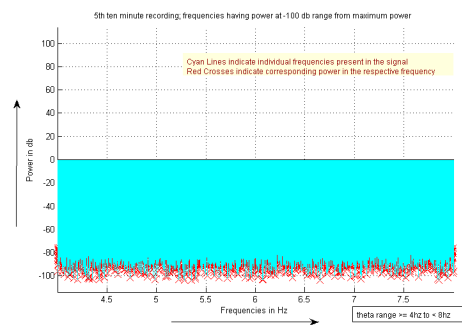

Fig. 47 Theta Range frequencies present at -100 db threshold in the Divine Omdasji Sound Meditation recording of the fifth ten minutes

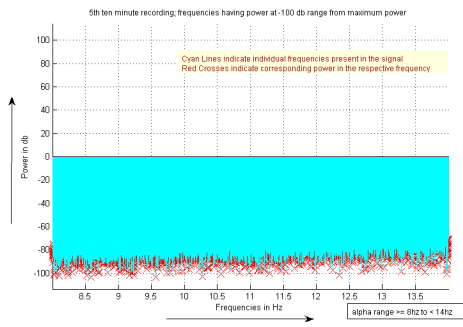

Fig. 48 Alpha Range frequencies present at -100 db threshold in the Divine Omdasji Sound Meditation recording of the fifth ten minutes

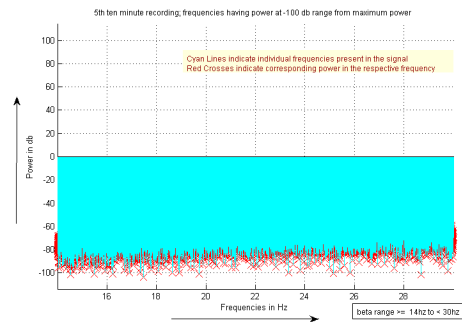

Fig. 49 Beta Range frequencies present at -100 db threshold in the Divine Omdasji Sound Meditation recording of the fifth ten minutes

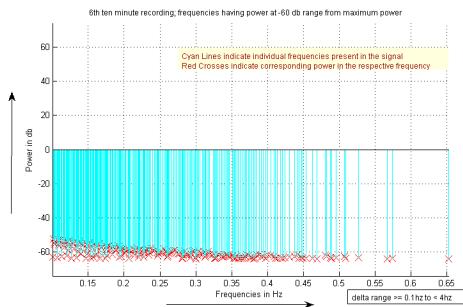

Fig. 50 Delta Range frequencies present at -60 db threshold in the Divine Omdasji Sound Meditation recording of the sixth ten minutes

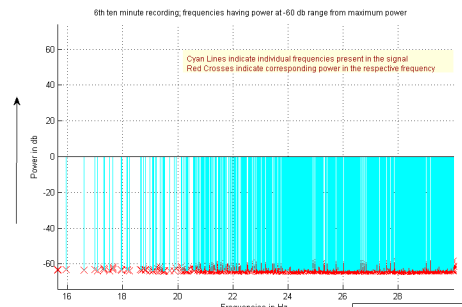

Fig. 51 Beta Range frequencies present at -60 db threshold in the Divine Omdasji Sound Meditation recording of the sixth ten minutes

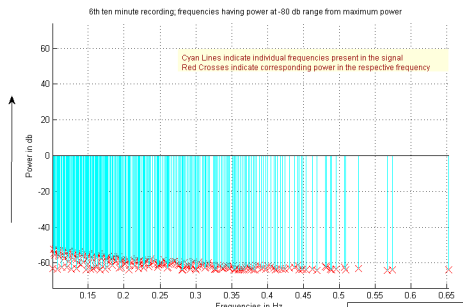

Fig. 52 Delta Range frequencies present at -80 db threshold in the Divine Omdasji Sound Meditation recording of the sixth ten minutes

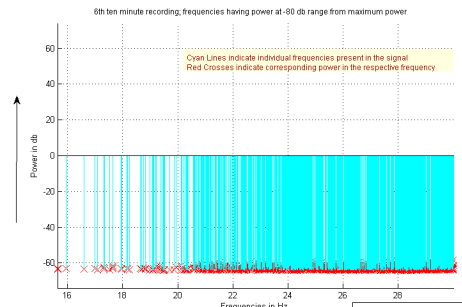

Fig. 53 Beta Range frequencies present at -80 db threshold in the Divine Omdasji Sound Meditation recording of the sixth ten minutes

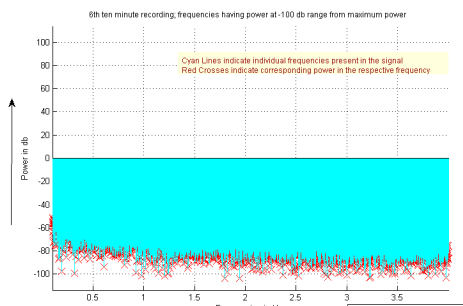

Fig. 54 Delta Range frequencies present at -100 db threshold in the Divine Omdasji Sound Meditation recording of the sixth ten minutes

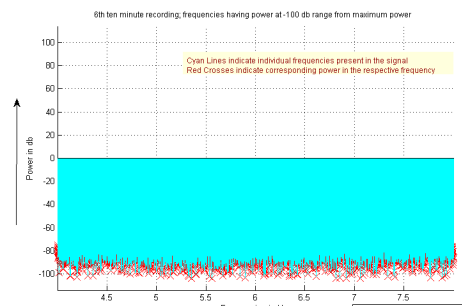

Fig. 55 Theta Range frequencies present at -100 db threshold in the Divine Omdasji Sound Meditation recording of the sixth ten minutes

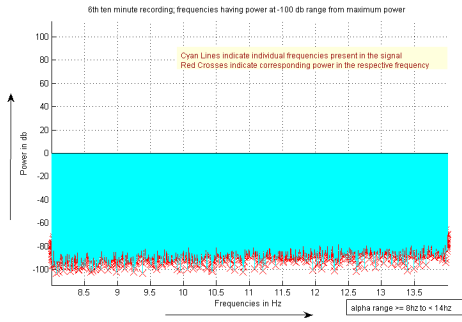

Fig. 56 Alpha Range frequencies present at -100 db threshold in the Divine Omdasji Sound Meditation recording of the sixth ten minutes

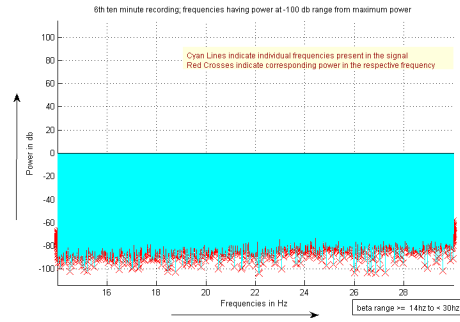

Fig. 57 Beta Range frequencies present at -100 db threshold in the Divine Omdasji Sound Meditation recording of the sixth ten minutes

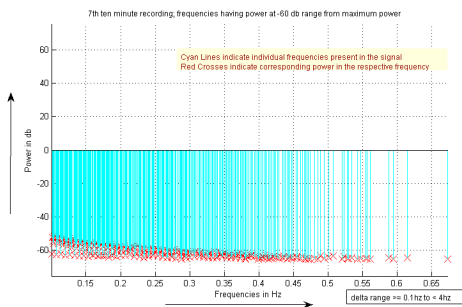

Fig. 58 Delta Range frequencies present at -60 db threshold in the Divine Omdasji Sound Meditation recording of the seventh ten minutes

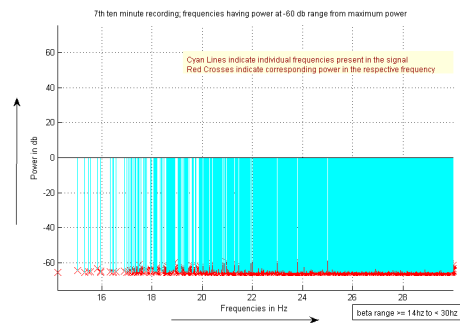

Fig. 59 Beta Range frequencies present at -60 db threshold in the Divine Omdasji Sound Meditation recording of the seventh ten minutes

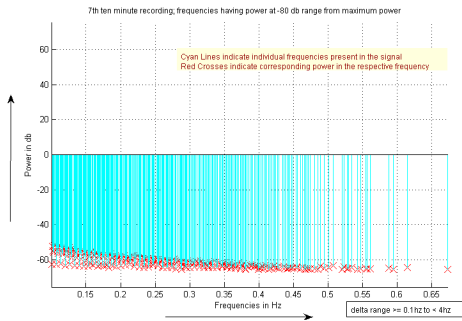

Fig. 60 Delta Range frequencies present at -80 db threshold in the Divine Omdasji Sound Meditation recording of the seventh ten minutes

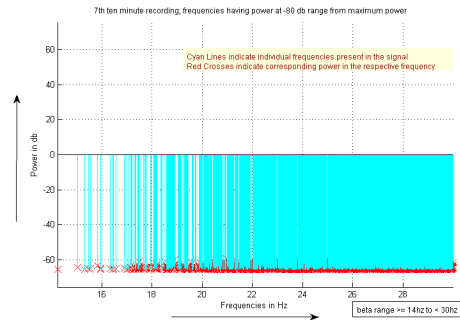

Fig. 61 Beta Range frequencies present at -80 db threshold in the Divine Omdasji Sound Meditation recording of the seventh ten minutes

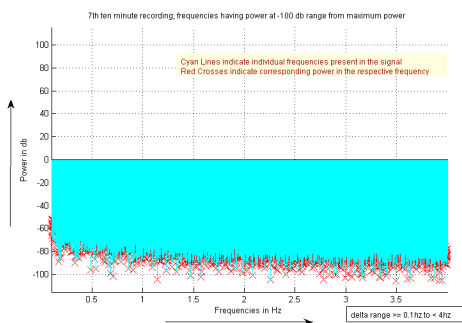

Fig. 62 Delta Range frequencies present at -100 db threshold in the Divine Omdasji Sound Meditation recording of the seventh ten minutes

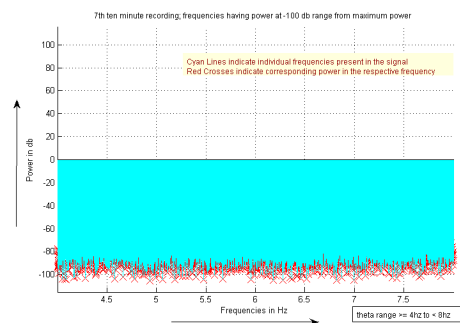

Fig. 63 Theta Range frequencies present at -100 db threshold in the Divine Omdasji Sound Meditation recording of the seventh ten minutes

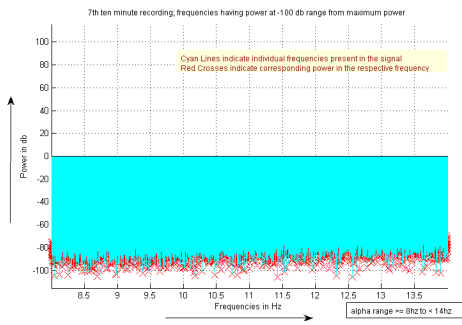

Fig. 64 Alpha Range frequencies present at -100 db threshold in the Divine Omdasji Sound Meditation recording of the seventh ten minutes

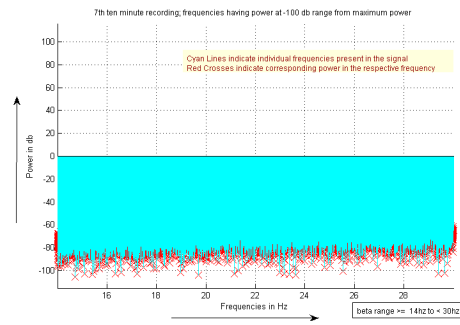

Fig. 65 Beta Range frequencies present at -100 db threshold in the Divine Omdasji Sound Meditation recording of the seventh ten minutes

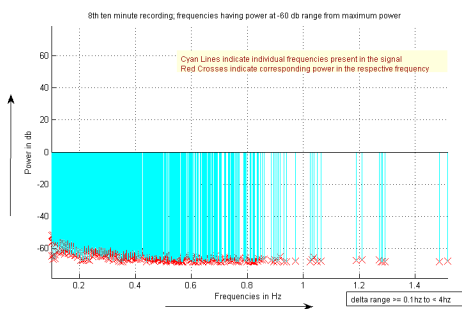

Fig. 66 Delta Range frequencies present at -60 db threshold in the Divine Omdasji Sound Meditation recording of the eighth ten minutes

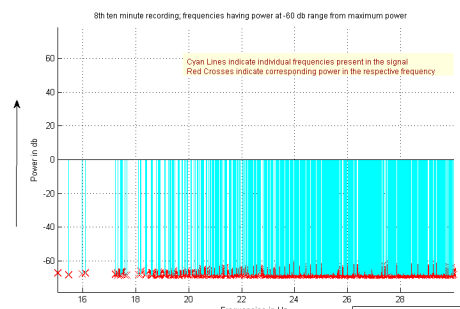

Fig. 67 Beta Range frequencies present at -60 db threshold in the Divine Omdasji Sound Meditation recording of the eighth ten minutes

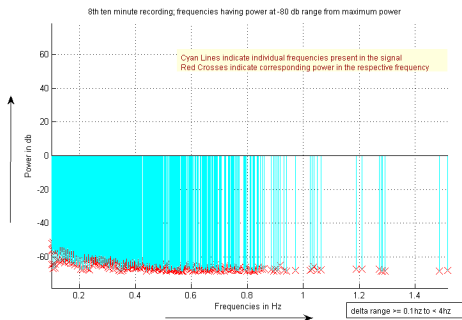

Fig. 68 Delta Range frequencies present at -80 db threshold in the Divine Omdasji Sound Meditation recording of the eighth ten minutes

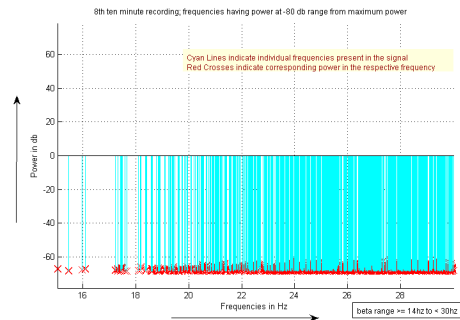

Fig. 69 Beta Range frequencies present at -80 db threshold in the Divine Omdasji Sound Meditation recording of the eighth ten minutes

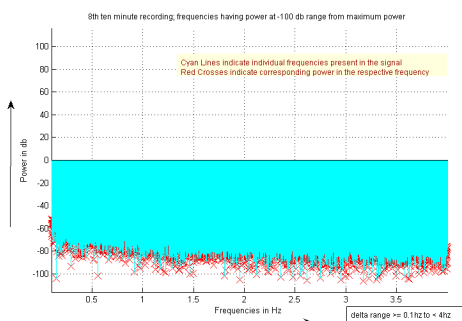

Fig. 70 Delta Range frequencies present at -100 db threshold in the Divine Omdasji Sound Meditation recording of the eighth ten minutes

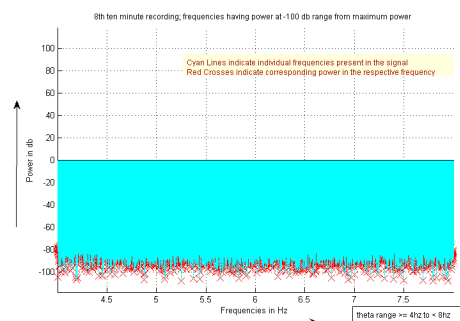

Fig. 71 Theta Range frequencies present at -100 db threshold in the Divine Omdasji Sound Meditation recording of the eighth ten minutes

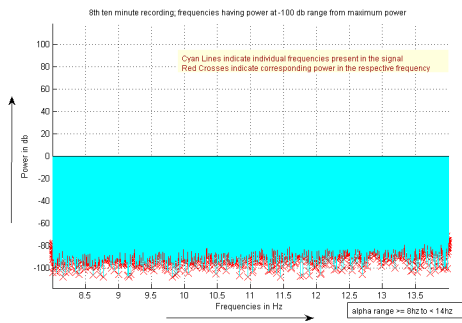

Fig. 72 Alpha Range frequencies present at -100 db threshold in the Divine Omdasji Sound Meditation recording of the eighth ten minutes

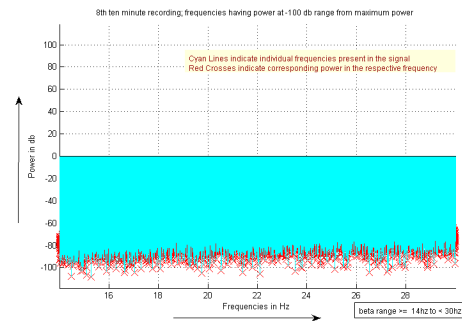

Fig. 73 Beta Range frequencies present at -100 db threshold in the Divine Omdasji Sound Meditation recording of the eighth ten minutes

**INFERENCES**

Figures 4 to 17 show the frequencies present in the Divine Omdasji Sound Meditation first ten minute recording. Figures 18 to 73 represent the frequencies present in the other recordings (from 2<sup>nd</sup> to 8<sup>th</sup> ten minute recording) of the Divine Omdasji Sound Meditation. Careful observation of Figures 4 to 17 conveyed the following information.

**Delta: Greater than or equal to 0.1 Hz to less than 4 Hz**

1. Absent in the -40 db level threshold
2. Present in the -60 db, -80 db & -100 db level thresholds
3. Clusters of frequency components observed below 1Hz and above 3Hz in the Delta Range at -60 db and -80 db level thresholds
4. The entire Delta range of frequencies seem to be present in the -100 db level threshold indicating presence of the complete band of Delta range of frequencies.

**Theta: Greater than or equal to 4 Hz to less than 8 Hz**

1. Absent in the -40 db level threshold
2. Present in the -60 db, -80 db & -100 db level thresholds
3. Clusters of frequencies observed with non-periodic absence of frequencies within the theta range in both the -60 db and -80 db level thresholds
4. The entire Theta range of frequencies seem to be present in the -100 db level threshold indicating presence of the

complete band of Alpha range of frequencies.

**Alpha: Greater than or equal to 8 Hz to less than 14 Hz**

1. Present in the -40 db, -60 db, -80 db and -100 db thresholds
2. In the -40 db level, frequencies are sparsely present with predominant non-periodic absence of frequencies manifested.
3. Majority of frequencies are present in -60 db & -80 db thresholds, with occasional non-periodic absence of some frequencies.
4. The entire Alpha range of frequencies seem to be present in the -100 db level threshold indicating presence of the complete band of Alpha range of frequencies.

**Beta: Greater than or equal to 14 Hz to less than 30 Hz**

1. Present in the -40 db, -60 db, -80 db and -100 db thresholds
2. In the -40 db level, minority presence of frequencies is observed with major gaps caused by absence of frequencies.
3. The entire Beta range of frequencies seem to be present in the -60 db, -80 db and -100 db level thresholds indicating presence of the complete band of Beta range of frequencies.

**DISCUSSION ON EXPERIMENTAL FINDINGS**

**1. Presence of audio frequencies corresponding to EEG rhythms.**

The observations (discussed in the previous paragraphs) have thus established the presence of audio frequencies corresponding to the various EEG rhythms.

**2. Interpretation of the relationship between the presence of audio frequencies corresponding to EEG rhythms and the human subjects' alteration in their EEG brain waves.**

It is conventionally known that human subjects experience alteration in various biophysical responses including EEG rhythms on listening to the Divine Omdasji Sound Meditation. The scope of this research work is related to EEG rhythms and hence the discussion restricts to EEG rhythms only.

It is a renowned fact that the EEG rhythms of inexperienced meditators can shift between alpha and beta states, while those of the experienced meditators can shift between any of the four states of delta, theta, alpha & beta. In the observations of the Divine Omdasji Sound Meditation, it is found that frequencies are present in the alpha and beta ranges at a comparatively higher power level of -40 db (from maximum power level), whereas at lower power levels of -60 db and -80 db the frequencies are present as majority accompanied with absence of some frequencies. The -100 db level is characterized by the presence of frequencies over the entire band completely.

This agrees with the conventional wisdom that inexperienced meditators will be able to resonate to meditative guidances at alpha and beta EEG states, while the more experienced meditators will be able to absorb and resonate to the more subtle (lower power) delta and theta EEG states in addition to the alpha and beta EEG states.

This absorption of meditative guidance and resonance of the human subjects to the Divine Omdasji Sound Meditation could be explained as phenomena similar to auditory evoked potentials or auditory steady state responses (though the phenomena are not exactly the same).

**3. Interpretation Hypothesis of the phenomena of the guidance exhibited by the Divine Omdasji Sound Meditation to the human subjects' EEG brain waves alterations.**

The discussions under the previous two subheadings have explained the presence of audio

frequencies in the Divine Omdasji Sound Meditation corresponding to human EEG brain waves and the relationship between the Divine Omdasji Sound Meditation and alteration in the human subjects' EEG brain waves. It is found that except some portions of the beta range, the other ranges of delta, theta and alpha fall in the inaudible range of audio frequencies and the Divine Omdasji Sound Meditation is an auditory meditative guidance phenomena. The medium of guidance or resonance can be explained using the concept of biophotons and their communication [30].

A summary of the above discussion sheds light on the fact that the Divine Omdasji Sound Meditation exhibit a meditative guidance leading the human subjects' EEG brain waves into low and very low frequency rhythms possibly through the concept of biophoton communication, similar to auditory evoked potentials or auditory steady state responses; the only difference being that the frequency ranges of interest fall in the inaudible levels for human beings, called Infrasound.

**4. Safe Infrasound Power levels in the Divine Omdasji Sound Meditation**

The earlier discussions establish the presence of infrasound in the Divine Omdasji Sound Meditation. But there has been widespread apprehensions and anxiety about infrasound. Infrasound is acoustic energy with frequencies up to 20 Hertz (Hz), having wavelengths of 17 m or more [31].

The American Conference of Governmental Industrial Hygienists (ACGIH) recommends that except for impulsive sound with durations of less than 2 seconds, one-third octave levels for frequencies between 1 and 80 Hz should not exceed a SPL ceiling limit of 145 dB, and the overall unweighted SPL should not exceed a SPL ceiling limit of 150 dB; no time limits are specified for these recommended levels [32]. It was concluded that short periods of continuous exposures to infrasound below 150 dB are safe and that continuous exposures up to 24 hours are safe if the levels are below 118 dB [33].

It is found that the maximum db power of the Divine Omdasji Sound Meditation signal is only - **3.9807 db** and hence continuous 24 hour exposure to Divine Omdasji Sound Meditation would perfectly be safe, judging by the standards set [33].

Also dense spectra of infrasound is found in the -100db level (from maximum signal power) and gradually decreases until it becomes a sparse spectra in the -40 db level (from maximum signal power) accompanied with total absence of certain frequency ranges (shown in figures 6 – 17; also indicated in Table 1). The number of frequency components in each range is given in Table 1.

The maximum signal power **-3.9807 db** lies very much within the safe margin for human exposure compared with the levels given [33]. It is hence established that the Divine Omdasji Sound Meditation should be safe for human physiological systems and continuous 24 hour exposure to Divine Omdasji Sound Meditation as a meditative source may not affect the physiological systems because the maximum db power of the Divine Omdasji Sound Meditation signal is only -3.9807 db. It should be noted that this discussion concerns strictly with the Divine Omdasji Sound Meditation signals below 30 Hz and the standards set for the infrasound [33]. The signal power of the audible Divine Omdasji Sound Meditation

signals above 30 Hz has not been investigated here as it does not fall within the scope of this research work.

### MEDITATIVE GUIDANCE VIA LOW DECIBEL POWER INFRASOUND IN DIVINE OMDASJI SOUND MEDITATION

The presence of infrasound in the Divine Omdasji Sound Meditation, accompanied with very low power and similarity in the -60db and -80db ranges (as shown in Table 1) was intriguing and sparked interest for further investigation. Hence, the number of frequency components falling in the respective regions was tabulated for all 8 recordings of the Divine Omdasji Sound Meditation. The odd numbered recordings correspond to 10 minute recordings from the first second of the Divine Omdasji Sound Meditation, with 5 minute interval between successive odd numbered recordings. The even numbered recordings are similar to the odd numbered recordings but start immediately after the 5<sup>th</sup> minute of the Divine Omdasji Sound Meditation and have 5 minute intervals between successive 10 minutes even numbered recordings.

**Table 1. Number of Frequency Components in each frequency range in the first ten minutes**

	<b>delta</b> >=0.1 to <4 hz	<b>theta</b> >=4 to <8 hz	<b>alpha</b> >=8 to <14 hz	<b>beta</b> >= 14 to <30 hz
<b>-40db</b>	0	0	726	660
<b>-60db</b>	530	3618	6168	16140
<b>-80db</b>	530	3618	6168	16140
<b>-100db</b>	4088	4194	6292	16777

Table 1 shows the number of frequency components in each range. The sampling rate is 8K and duration of recording is 600 seconds. The db levels indicate the range between the maximum signal power and the indicated value (in db). The values in the table indicate the number of frequency components present in the signal within the given frequency ranges (in hz) and the power levels (in db). Though infrasounds lie below 20Hz, this table also indicates the beta range (14 to 30 Hz) since it is essential with regard to meditative perspectives relating to EEG frequency ranges.

**Table 2. Number of Frequency Components in each frequency range in the second ten minutes**

	<b>delta</b> >=0.1 to <4 hz	<b>theta</b> >=4 to <8 hz	<b>alpha</b> >=8 to <14 hz	<b>beta</b> >= 14 to <30 hz
<b>-40db</b>	0	0	0	0
<b>-60db</b>	151	0	0	390
<b>-80db</b>	151	0	0	390
<b>-100db</b>	4079	4168	6269	16771



**Table 3. Number of Frequency Components in each frequency range in the third ten minutes**

	<b>delta</b> >=0.1 to <4 hz	<b>theta</b> >=4 to <8 hz	<b>alpha</b> >=8 to <14 hz	<b>beta</b> >= 14 to <30 hz
<b>-40db</b>	0	0	0	0
<b>-60db</b>	146	0	0	437
<b>-80db</b>	146	0	0	437
<b>-100db</b>	4078	4151	6269	16769

**Table 4. Number of Frequency Components in each frequency range in the fourth ten minutes**

	<b>delta</b> >=0.1 to <4 hz	<b>theta</b> >=4 to <8 hz	<b>alpha</b> >=8 to <14 hz	<b>beta</b> >= 14 to <30 hz
<b>-40db</b>	0	0	0	0
<b>-60db</b>	161	0	0	544
<b>-80db</b>	161	0	0	544
<b>-100db</b>	4078	4167	6269	16764

**Table 5. Number of Frequency Components in each frequency range in the fifth ten minutes**

	<b>delta</b> >=0.1 to <4 hz	<b>theta</b> >=4 to <8 hz	<b>alpha</b> >=8 to <14 hz	<b>beta</b> >= 14 to <30 hz
<b>-40db</b>	0	0	0	0
<b>-60db</b>	211	0	0	1262
<b>-80db</b>	211	0	0	1262
<b>-100db</b>	4080	4166	6274	16773

**Table 6. Number of Frequency Components in each frequency range in the sixth ten minutes**

	<b>delta</b> >=0.1 to <4 hz	<b>theta</b> >=4 to <8 hz	<b>alpha</b> >=8 to <14 hz	<b>beta</b> >= 14 to <30 hz
<b>-40db</b>	0	0	0	0
<b>-60db</b>	221	0	0	1271
<b>-80db</b>	221	0	0	1271
<b>-100db</b>	4079	4166	6274	16773

**Table 7. Number of Frequency Components in each frequency range in the seventh ten minutes**

	<b>delta</b> >=0.1 to <4 hz	<b>theta</b> >=4 to <8 hz	<b>alpha</b> >=8 to <14 hz	<b>beta</b> >= 14 to <30 hz
<b>-40db</b>	0	0	0	0
<b>-60db</b>	272	0	0	2219
<b>-80db</b>	272	0	0	2219
<b>-100db</b>	4081	4174	6282	16770

**Table 8. Number of Frequency Components in each frequency range in the eighth ten minutes**

	<b>delta &gt;=0.1 to &lt;4 hz</b>	<b>theta &gt;=4 to &lt;8 hz</b>	<b>alpha &gt;=8 to &lt;14 hz</b>	<b>beta &gt;= 14 to &lt;30 hz</b>
<b>-40db</b>	0	0	0	0
<b>-60db</b>	458	0	0	1953
<b>-80db</b>	458	0	0	1953
<b>-100db</b>	4086	4181	6280	16775

The tables seem to indicate some regularity and relation among the values tabulated. Meditative guidance is a continuous phenomenon. Hence surface plots were drawn using MATLAB for each of the tables.

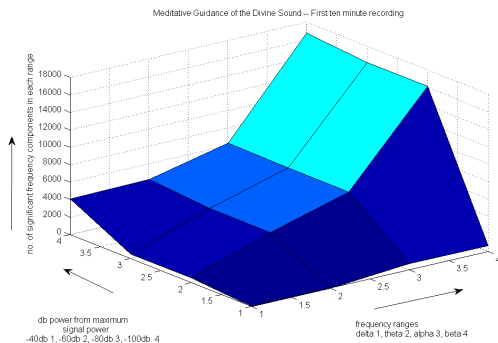

**Fig. 74** Plot of the Frequency components in the meditative frequency ranges at various power levels in the first ten minute recording

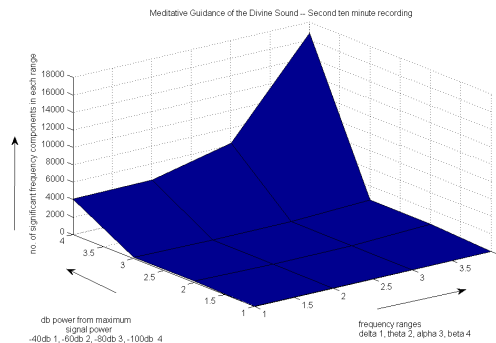

**Fig. 75** Plot of the Frequency components in the meditative frequency ranges at various power levels in the second ten minute recording

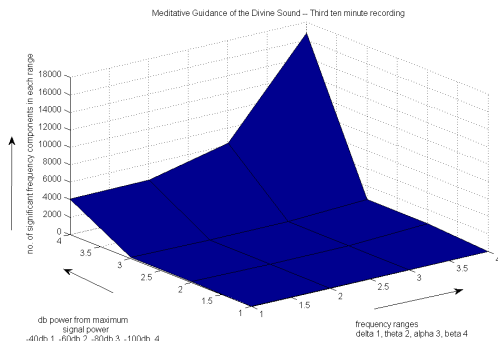

**Fig. 76** Plot of the Frequency components in the meditative frequency ranges at various power levels in the third ten minute recording

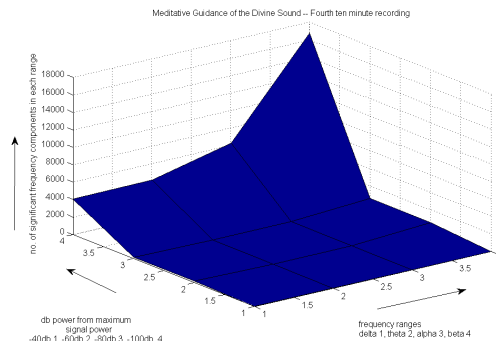

**Fig. 77** Plot of the Frequency components in the meditative frequency ranges at various power levels in the fourth ten minute recording

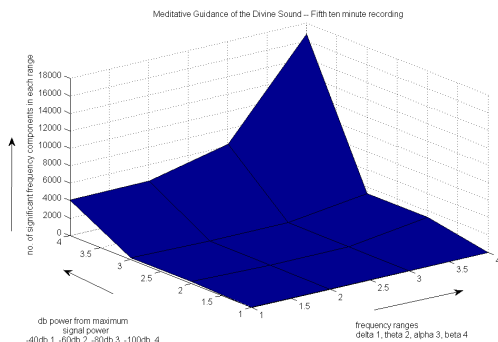

**Fig. 78** Plot of the Frequency components in the meditative frequency ranges at various power levels in the fifth ten minute recording

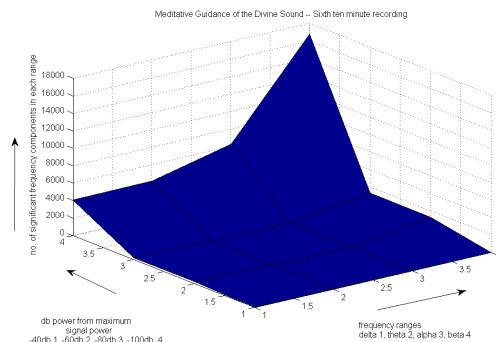

**Fig. 79** Plot of the Frequency components in the meditative frequency ranges at various power levels in the sixth ten minute recording

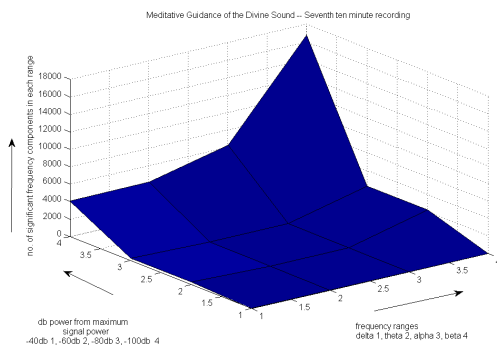

Fig. 80 Plot of the Frequency components in the meditative frequency ranges at various power levels in the seventh ten minute recording

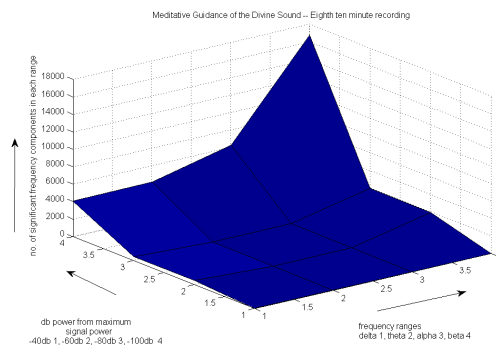

Fig. 81 Plot of the Frequency components in the meditative frequency ranges at various power levels in the eighth ten minute recording

Any meditative guidance should be able to pick up a client from some stage of mental activity and guide them to stable meditative states. Evaluation of the 8 plots (Figs. 74-81) would help to arrive at a generalized inference. The most desired frequency range for deepest meditative state is the delta range, where there is total peace and calm. The surface of the plot (Fig. 74) slopes from high ranges of EEG meditative spectrum (beta) to the lower ranges. If it is assumed that the slope of the plot denotes the meditative guidance, then this hypothesis has to be checked with all the plots. The plot of the first ten minute recording (Fig. 74) up to the first ten minutes is considered. The plot slopes from -100 db of the beta range and gradually goes down to the delta range. It can be assumed that the DS meditative guidance initiates meditation from even clients who are even at high EEG meditative ranges of beta. The high concentration of DS samples at the -100db level beta range might imply that the DS meditative guidance acts so subtly that it picks up the meditative client at beta and initiates meditation so subtly (-100 db of maximum signal power) that even the client may not be aware of it.

Then, the slope of the plot gradually slopes towards the lower frequency ranges. The slope up to the theta level is very gradual and suddenly slopes towards delta. Perhaps, this might explain better the meditative guidance of the Divine Omdasji Sound Meditation. The Divine Omdasji Sound Meditation may be picking up the client at beta levels, so subtly without the awareness of the client and then slowly brings the client to theta levels and then tries to bring about a rapid change to delta levels. This could be the reason for clients rapidly going into very deep meditative states on the Divine Omdasji Sound Meditation meditative guidance. These inferences can be accepted if the other plots also corroborate the same inferences.

The plot of the second ten minute recording (Fig. 75) is considered. It is found that similar to the first plot, the

clients may be able to be picked up from higher levels of beta, at very subtle levels of -100 db. But a different characteristic is observed here. The slope of the plot is very rapid and settles down at the lower EEG meditative levels rapidly. This corroborates the inference of the first plot that the DS meditative guidance brings the clients to very low EEG states in the first few minutes itself as the second plot is actually an overlap of the first plot as the first plot is the recording from 0 to 10 minutes and the second plot is the recording from 5 to 15 minutes. Judged in conjunction, it is inferred that the Divine Omdasji Sound Meditation meditative guidance settles the client at very low meditative states in the first 15 minutes itself.

The Divine Omdasji Sound Meditation meditative guidance might start slowly; leading the client into lower EEG states and then rapidly lead the client into very low EEG meditative states that are symbolic of very good meditation. It is found that the inferences from the first two plots corroborate and also support each other.

The plot of the third ten minute recording (Fig. 76), 15 to 25 minutes of the Divine Omdasji Sound Meditation is considered. The plot of the third ten minute recording also resembles the second plot. The only possible inference could be that the meditative guidance leads the client into very low EEG meditative states. When the client has already reached very low EEG meditative states in the first two plots itself, then the third plot seems to be redundant meditative guidance.

This can be explained as follows: The Divine Omdasji Sound Meditation meditative guidance leads the client to very low EEG meditative states but the client may have experience internal or external disturbance to meditation or may even oscillate between meditative states. However may be the case, the meditative guidance exhibited by third plot ensures that the client

is led into very low EEG meditative states, by being able to pick them up from higher states (in case if they have wandered into higher states due to internal or external reasons).

Similar effects are observed in all plots henceforth and the same inference seems to hold. In summary, the Divine Omdasji Sound Meditation meditative guidance may be able to pick up a client from higher EEG states (even beta), in a subtle lead (-100 db power levels from maximum signal power) and guide them to very low EEG meditative states in about 15 minutes.

Also, it is found that the Divine Omdasji Sound Meditation meditative guidance may be able to maintain the very low EEG meditative states of the client, by being able to lead them again back to very low meditative EEG states (in the event of oscillation or drifting about meditative states) as inferred from the plots from the DS recordings of the second, third and fourth quarters of the hour.

The very low number of frequency components in theta and alpha ranges in many of the tables (Tables 2-8) would indicate that the DS meditative guidance permits clients to settle down in the theta and alpha levels. Yet, the presence of frequency components in the delta levels in many of the tables would indicate that the DS meditative guidance does offer leads in the delta levels as the delta meditative state is difficult to achieve and a client who goes into delta meditative states would need guidance to persist in the delta meditative states. Hence, the DS meditative guidance offers guidance at delta meditative states for a very long time.

## BIOPHOTONIC CONSCIOUSNESS COMMUNICATION

The research on bio-informational aspects of biophotons in the IR to UV range can be traced back to Alexander G. Gurwitsch more than seventy years ago. Despite serious experimental difficulties it is now clear to every scientist working in this field that photon emission could be detected from nearly all living cells. Bio-photons are characterized by their quantum character and are supposed to escape from a coherent field [30].

### *Biophotons*

Biophotons have frequencies in the range 200-800 nm. They are coherent weak radiation, almost 20 orders of magnitude weaker than common fluorescence of photophosphorence. Biophoton emission is a signature of living matter ([www.helsinki.fi/~matpitka/articles/biophotons.pdf](http://www.helsinki.fi/~matpitka/articles/biophotons.pdf) as on March 1, 2007)

According to the biophoton theory developed on the base of these discoveries the biophoton light is stored in the cells of the organism - more precisely, in the DNA molecules of their nuclei - and a dynamic web of light constantly released and absorbed by the DNA may connect cell organelles, cells, tissues, and organs within the body and serve as the organism's main communication network and as the principal regulating instance for all life processes.

The processes of morphogenesis, growth, differentiation and regeneration are also explained by the structuring and regulating activity of the coherent biophoton field. The holographic biophoton field of the brain and the nervous system, and maybe even that of the whole organism, may also be basis of memory and other phenomena of consciousness, as postulated by neurophysiologist Karl Pribram and others.

The consciousness-like coherence properties of the biophoton field are closely related to its base in the properties of the physical vacuum and indicate its possible role as an interface to the non-physical realms of mind, psyche and consciousness (<http://www.transpersonal.de/mbischof/englisch/webblookeng.htm> as on March 1, 2007)

Biophoton emission is a general phenomenon of living systems. It concerns low luminescence from a few up to some hundred photons-per-second per square-centimeter surface area. At least within the spectral region from 200 to 800nm. The experimental results indicate that biophotons originate from a coherent (or/and squeezed) photon field within the living organism, its function being intra- and inter-cellular regulation and communication [34].

### *Biophoton Communication*

Biological Systems are governed by the special interaction of a coherent electromagnetic field (biophotons) and biological matter. There is a permanent feedback coupling between field and matter in a way that the field directs the location and activity of matter, while matter provides the boundary conditions of the field. Since the field is almost fully coherent, the interference patterns of the field contain the necessary information about the regulatory function. The interference structures are not stable, but vary in concordance with the rather complex spatio-temporal interactions between field and matter ([http://www.lifescientists.de/ib0203e\\_1.htm](http://www.lifescientists.de/ib0203e_1.htm) as on March 2, 2007).

**BIOPHOTON COMMUNICATION AMONG  
MEDITATIVE CONSCIOUSNESS FIELDS**

An understanding of the earlier paragraphs on Meditative Consciousness fields suggests that the human source of the meditative music input and the human meditative subject would be generating a meditative consciousness field. Inferring in conjunction with the discussion on Biophoton Communication given above, the authors suggest a model of *Biophotonic Consciousness Communication* where the Meditative Consciousness Field of the human source would interact with the Meditative Consciousness Field of the human subject through biophotonic communication, where the alterations in consciousness states of the human subject caused due to Meditative Music Input would actually be guided by the alterations in consciousness states of the human source of meditative music input through biophotonic communication. Rephrased in a simple way, the human source would guide the human subject in alterations of consciousness states through biophotonic communication.

**ANALYSIS OF MULTIPLE PHASE LOCKED  
LOOP MEDITATIVE GUIDANCE USING  
BIOPHOTONIC COMMUNICATION AND  
BIOACOUSTIC FIELDS**

Referring to earlier paragraphs, it can be understood that the Divine Omdasji Sound Meditation guides meditating human subjects into deep meditation using Low Decibel Power Infrasound present in the chant. Also, we understand that the meditative consciousness fields of the human source and the human subject interact via biophoton communication.

Discussions in previous sections of the paper indicate that the Divine Omdasji Sound Meditation guides the meditating human subject into very deep meditative states characterized by very low frequency brainwaves and continues the guidance holding them in very deep meditative states using the low frequency infrasound present in the Divine Omdasji Sound Meditation chant.

Analytical examination yields the insight that there are actually two processes that perform meditative guidance in the Divine Omdasji Sound Meditation, viz., a biophotonic communication among the consciousness fields between those of the meditating lead/source and the meditating subject (that alters the consciousness states leading the subject to deep meditation) and a bioacoustic field between the meditating lead/source and the meditating subject manifested as low frequency infrasound present in the Divine Omdasji Sound Meditation chant (that guides the brain waves of the subject into states characteristic of deep meditation).

A logical inference is that the presence of two meditative guiding processes in Divine Omdasji Sound Meditation could be the reason for the much renowned and conventionally accepted fact in society that the Divine Omdasji Sound Meditation guides meditating human subjects into very deep meditative states effortlessly in a very short time and also continues to hold them in very deep meditative states. However, these inferences are valid only when there is one meditating lead/guru and one meditating subject/client. In cases where multiple meditating subjects/clients are guided in meditation simultaneously, certain concepts related to phase locked loops need to be suitably used to offer better explanation of meditative guidance as given below.

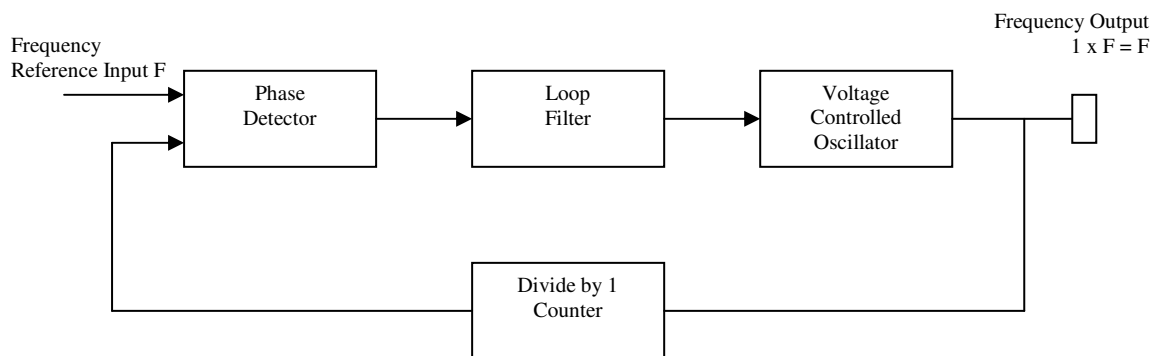

Fig 82. Block Diagram of a Phase Locked Loop (Courtesy: [www.cardinalxtal.com/docs/notes/cardinal\\_phase\\_lock\\_loop\\_basics.pdf](http://www.cardinalxtal.com/docs/notes/cardinal_phase_lock_loop_basics.pdf), as on Feb 28, 2007)

Figure 82 shows a Phase Locked Loop frequency multiplier. Since  $n = 1$ , the Voltage Controlled Oscillator gives an Output that is 1 times F, that is, F itself.

### ***Phase Locked Loop***

The Phase Locked Loop (PLL) is a conventional circuit used to lock to the input frequency when the frequency is within the PLL's bandwidth. The PLL is basically a feedback control system that controls the phase of the Voltage Controlled Oscillator (VCO). The input signal is applied to one input of a phase detector. The other input is taken from the output of a Divide by 1 Counter.

The output of the Phase Detector will be a difference of the phases of the two inputs, and is applied to the Loop Filter. The Loop Filter determines the dynamic characteristics of the PLL and controls the VCO. The output frequency is N times the input, governed by the Divide by N counter. In a specific case of  $N = 1$ , the Divide by N counter becomes a Divide by 1 Counter, and the output frequency is exactly the same as the input frequency.

The design of the Loop Filter is decided by the proposed application of the PLL. If the PLL expects a single input frequency, then the bandwidth of the Loop Filter can be narrow. If the PLL is required to acquire and track a signal, then the bandwidth of the Loop Filter will be suitably larger [35].

Extending the PLL as a multiple phase locked loop and applying inferences derived from earlier paragraphs in conjunction with earlier findings [36], it can be understood that the Divine Omdasji Sound Meditation leads multiple meditating subjects into deep meditative states on the strengths of the relationship between the meditating lead/guru and the meditating subjects/clients brought about by biophotonic communication and bioacoustic fields in multiple phase locked loop manner.

### ***Earlier Analysis***

An analysis was attempted of the expected instantaneous results of the Multiple Phase Locked Loop Meditative Guidance using BioPhotonic Communication and BioAcoustic Fields (herein after referred to as the Process) on multiple simultaneously meditating subjects/clients [37].

Personal state of mind or acceptance of the process could be a positive catalyst, where the process is able to work without hurdles caused by non-synchronism of the meditating lead/guru and the meditating subjects/clients.

Higher level activities in the brain during the process could induce wastage of the mental resources of the

meditating clients, consequently affecting synchronism of the lead and the clients.

Force of the intent of the client and strength of the consciousness field brought by faith in the process and surrender of the self could possibly increase efficiency of the process.

However, absence of faith in the process cannot be taken as a constraint, as it violates the primary analytical inference that the process should be able to calm and soothe the mind. Absence of faith in the process could possibly create an agitated consciousness field in the client which could easily be calmed down by the process, and the process should work, the end result being the same except for the time taken to soothe the agitated consciousness field and achieve synchronism between the lead and the client.

Judging from the analytical inferences arrived at, it can be understood the process should also have some limitations.

These limitations to efficient working of the process could possibly arise due to the influence of alcohol, or heavy medication or drugs, where the biological systems of the body nor the consciousness fields of the referred client is unable to synchronise with that of the meditating lead/guru. It can be understood that loss of sensitivity of the biological and mental systems of the client could possibly be the reason, in which case the power levels of the Divine Omdasji Sound Meditation may suitably increased to overcome the loss of sensitivity of the referred client. However, if required, such clients may be treated by the process isolated from normal clients, as normal clients may not need higher power levels.

One advantage of the process from the perspective of the client could be that apriori knowledge of the process may not be required, as conventional observations of the process in the past has noted that the process is effective on clients who are not aware of the actual mechanism of the process. Hence, these scientific analyses done so far, have only corroborated with conventional observations, though explaining in scientific ways the actual process involved. Future research work is expected to concentrate on providing scientific explanations to effects of the process already observed conventionally. Further, it is expected that some subtle effects conventionally unnoticed may also be unraveled.

### Retro-Analysis

In retrospect, there arises a few queries. The above analysis may be valid when the distance between the meditating lead/guru and the meditating subjects/clients is very small. However, when the distance between the lead and the clients is very large compared to the speed at which sound travels, then the distance factor assumes prominence. In such a case, the bioacoustic field effect in the process decreases, while the biophotonic communication and the consciousness fields factor are not affected.

In order to achieve the same efficiency of the process as obtained earlier, to the case where the effect of the bioacoustic field decreases, then there can be a suitable modification in the weightage given to the three factors, *viz.*, bioacoustic field, biophotonic communication and consciousness fields.

When weightage given to the consciousness fields is increased, then communication between the consciousness fields of the meditating lead/guru and the meditating subjects/clients can be accomplished using the universal consciousness field [38]. Using the same field, biophotonic communication can be established at a relatively shorter time. The bioacoustic field, can be generated as an acoustic field, with the same embedded acoustic guidance for meditation, which when linked by the clients to the Universal Consciousness Field, finds the meditative guidance embedded in it which helps to replicate the bioacoustic field meditative guidance.

In summary, the above inferences yield insight that with suitable modifications, the meditative guidance offered by the Divine Omdasji Sound Meditation can be effectively utilized by simultaneously meditating clients even at very far distances from the meditating lead/guru with suitable modifications in the generation of the bioacoustic field and the consciousness field linkages and consciousness communications.

### ACKNOWLEDGEMENT

The first author thanks her parents and Shri.V.S.Mani for orienting her towards the path of education and spirituality. The second author acknowledges his parents and dedicates this research work unto his mother Annie Nazareth who is his guide (though not physically alive) and all other good souls. The ninth author acknowledges his Guru, Dhyanyogi Madhusudandasji Maharaj. The authors acknowledge the contribution of Dr.M.Mohanan. The authors acknowledge the discussions with Dr. Aruna Ganesan and Dr. Arivuoli. The authors thank the Chancellor of Vinayaka Missions University

Dr.A.Shanmugasundaram, the ProChancellors Dr.S.Sharavanan and Dr.A.S.Ganesan, the Vice Presidents Mr.J.S.Satish Kumar and Mr.N.V.Chandrasekhar, the Vice Chancellor, the Registrar, Dr. A. Nagappan Principal VMKV Engineering College and University/College Authorities/Officials for their patronage.

### REFERENCES

- [1] Takahashi T., Murata T., Hamada T., Omori M., Kosaka H., Kikuchi M., Yoshida H., Wada Y. (2005) Changes in EEG and autonomic nervous activity during meditation and their association with personality traits, *Int J Psychophysiol.* 55(2):199-207.
- [2] Mason L.I., Alexander C.N., Travis F.T., et al. (1997) Electrophysiological correlates of higher states of consciousness during sleep in long-term practitioners of the Transcendental Meditation Program. *Sleep* 20, 102–110.
- [3] Wallace R.K., H. Benson, A.F. Wilson (1971) A wakeful hypometabolic physiologic state, *Am. J. Physiol.* 221:795–799.
- [4] Monk-Turner E. (2003) The benefits of meditation: experimental findings. *The Social Science Journal* 40:465–470
- [5] Benson H., J.F. Beary, M.P. Carol (1974) The relaxation response, *Psychiatry* 37: 37– 46.
- [6] Domar A.D., M.M. Seibel, H. Benson (1990) The Mind/Body Program for Infertility: a new behavioral therapy approach for women with infertility, *Fertil. Steril.* 53: 246– 249.
- [7] Goodale I.L., A.D. Domar, H. Benson (1990) Alleviation of premenstrual syndrome symptoms with the relaxation response, *Obstet. Gynecol.* 75: 649– 655.
- [8] Jacobs G.D., H. Benson, R. Friedman (1996) Topographic EEG mapping of the relaxation response, *Biofeedback Self-Regul.* 21: 121– 129.
- [9] Lazar S.W. , G. Bush, R.L. Gollub, G.L. Fricchione, G. Khalsa, H. Benson (2000) Functional brain mapping of the relaxation response and meditation, *NeuroReport* 11: 1581– 1585.
- [10] Cardoso R, Eduardo de Souzaa, Camanoa L., Leite J.R. (2004) Meditation in health: an operational definition, *Brain Research Protocols* 14: 58– 60
- [11] Hebert R., Lehmann D. (1977) Theta bursts: an EEG pattern in normal subjects practising the transcendental meditation technique, *Electroencephalogr Clin Neurophysiol.* 42(3):397-405.
- [12] Taylor, J.G. (1999) *The Race for Consciousness*, MIT Press
- [13] Markowitsch H.J. (1995) Cerebral basis of consciousness: a historical view. *Neuropsychol.* 33(9):1181-92
- [14] Travis F.T., Orme-Johnson D.W. (1989) Field model of consciousness: EEG coherence changes as indicators of field effects, *Int J Neurosci.* 49(3-4):203-11.
- [15] Austin, J. H. (1998) *Zen and the Brain*. MIT

- [16] Asbbrook J.B. (1996) Interfacing Religion and the Neurosciences: A Review of Twenty-Five years of Exploration and Reflection. *Zygon*, vol. 31, no. 4.
- [17] Hopfinger J.B. et al. (2000) The neural mechanisms of top-down attentional control. *Nat. Neurosci.* 3: 284–291
- [18] Kastner S., Ungerleider L. G. (2000) Mechanisms of visual attention in the human cortex. *Annu. Rev. Neurosci.* 23:315–341
- [19] Taylor J.G. (2002) Paying attention to consciousness. *Trends in Cognitive Sciences* 6(5):206-210
- [20] Cotterill R. M. J. (2001) Cooperation of basal ganglia, cerebellum, sensory cerebrum and hippocampus: possible implications for cognition, consciousness, intelligence and creativity. *Prog. Neurobiol.* 64: 1–33
- [21] Gallagher S. (2000) Philosophical conceptions of the self: implications for cognitive science. *Trends Cogn. Sci.* 4: 14–21
- [22] Frith C. (1992) *The Cognitive Neuropsychology of Schizophrenia*, Erlbaum
- [23] Tassi P, Muzet A. (2001) Defining the states of consciousness. *Neuroscience and Biobehavioural Reviews* 25:175-191
- [24] West M. (1979) Meditation, *Br. J. Psychiatry* 135: 457–467.
- [25] Braud W. G. (1975) Psi- Conducive States. *Journal of Communication* 25 (1): 142-152
- [26] Khalsa D.S. (2000) Medical Meditations. *Total Health* Vol. 22 No. 4 pp. 59 – 61
- [27] Kaplan S. (1978) An Appraisal of a Psychological Approach to Meditation. *Zygon* Vol. 13 No. 1 pp. 83-101
- [28] Plourde G. (2006) Auditory evoked potentials. *Best Practice & Research Clinical Anaesthesiology* Vol. 20, No. 1, pp. 129-139
- [29] Krishnan A. (2002) Human frequency-following responses: representation of steady-state synthetic vowels. *Hearing Research.* 166:192-201
- [30] VanWijk R. (2001), Bio-photons and Bio-communication, *Journal of Scientific Exploration*, Vol. 15, No. 2, pp. 183-197
- [31] Infrasound. Brief Review of Toxicological Literature (2001). 51 pages. [ntp.niehs.nih.gov/ntp/htdocs/Chem\\_Background/ExSumPdf/Infrasound.pdf](http://ntp.niehs.nih.gov/ntp/htdocs/Chem_Background/ExSumPdf/Infrasound.pdf) (last accessed March 6, 2007)
- [32] ACGIH (2001). *Infrasound and Low-Frequency Sound*. In: *Documentation of the Threshold Limit Values for Physical Agents*. ACGIH Worldwide. Cincinnati, OH. pp 1-15.
- [33] Johnson D.L. (1982). Hearing hazards associated with infrasound. In: *New Perspectives on Noise-induced Hearing Loss*, Hamernik, R.P., D. Henderson, and R. Salvi (eds). New York: Raven Press. pp. 407-421.
- [34] Fritz-Albert Popp (1999) About the Coherence of Biophotons. Published in: "Macroscopic Quantum Coherence", *Proceedings of an International Conference on the Boston University*, edited by Boston University and MIT, World Scientific
- [35] [www.cardinalxtal.com/docs/notes/cardinal\\_phase\\_lock\\_loop\\_basics.pdf](http://www.cardinalxtal.com/docs/notes/cardinal_phase_lock_loop_basics.pdf) (as on Feb 28, 2007)
- [36] Neela Iyer, A.Prabhu Britto, Vladimir Petrov Velikov, Justin Chernow, Elizabeth Maier, Dr. A. Nagappan, Dr.M.Rangasamy, Dr. N. Malmurugan and Dhyanyogi Omdasji Maharaj (2008) Multiple Phase Locked Loop Guidance in Meditation: A New Scientific Explanation. *The Journal of Yoga*, Vol. 7, Number 2, Spring/Summer 2008 <http://www.journalofyoga.org/>.
- [37] Neela Iyer, A.Prabhu Britto, K. Sridhar, Justin Chernow, Elizabeth Maier, Sant Maa Vaishnavi Devi, Sant Maa Ananta Devi, Sant Maa Aparna Devi, Dhyanyogi Omdasji Maharaj (2009) Multiple Phase Locked Loop Meditative Guidance using BioPhotonic Communication and BioAcoustic Fields -- An Analysis. *International Journal of Life Sciences and Technology IJLST* (2009), 2(1):1-24.
- [38] <http://www.shareguide.com/Hagelin.html> as on March 17, 2009